

Custom Printed Latex Caps

ERLSP

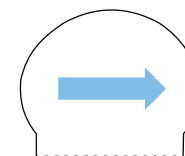

Any logo which must face the same direction on both sides of cap when worn will require separate screens for each side of cap.

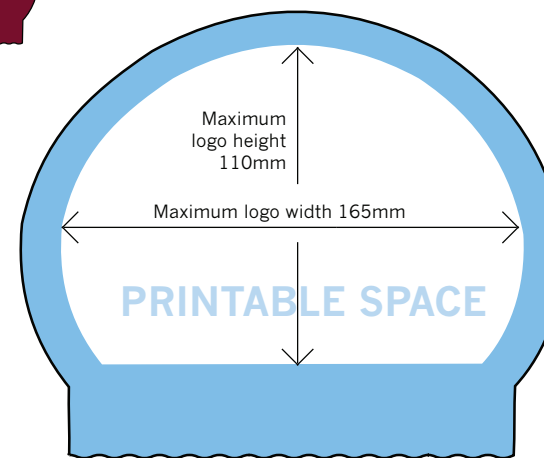

- Minimum quantity for latex cap printing is 50pcs per cap colour/per logo colour/per design
- Some cap/logo colour combinations will require an additional underbase of white to achieve best colour result. If a white is not part of the original logo an additional screen charge will apply.
- If caps are to be used for competition events under FINA rules then this must be advised on order as restrictions are placed upon the size of the manufacturers mark.
- All logo printed caps will come with an eyeline logo printed on cap as a manufacturers mark.

Custom Printed Silicone Caps

ESCSP

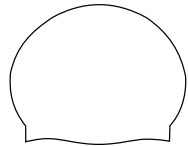

white

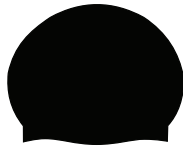

black

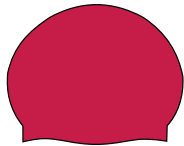

red

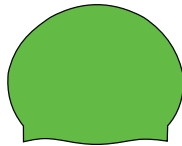

mint green

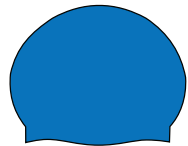

metal blue

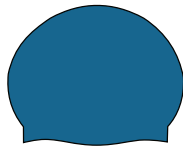

metal green



navy

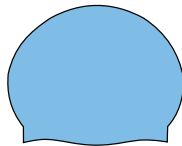

powder blue

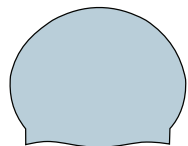

silver

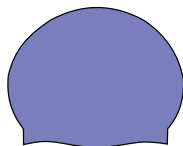

purple

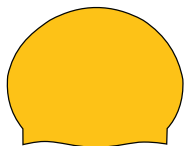

buttercup yellow

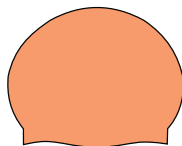

neon orange

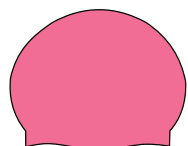

neon pink

- Minimum quantity for regular silicone cap printing is 30pcs per cap colour/per logo colour/per design
- Some cap/logo colour combinations will require an additional underbase of white to achieve best colour result. If a white is not part of the original logo an additional screen charge will apply.
- If caps are to be used for competition events under FINA rules then this must be advised on order as restrictions are placed upon the size of the manufacturers mark.
- All logo printed caps will come with an eyeline logo printed on cap as a manufacturers mark.

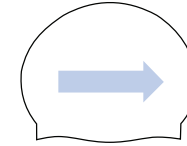

Any logo which must face the same direction on both sides of cap when worn will require separate screens for each side of cap.

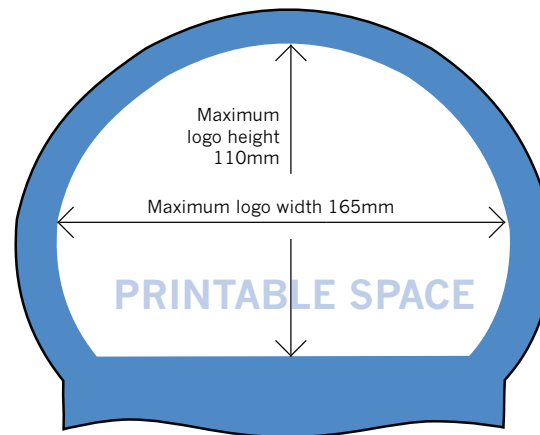

Swim Caps | Custom Printed

Custom Printed Seamless Silicone Racing Caps

ESSCSP

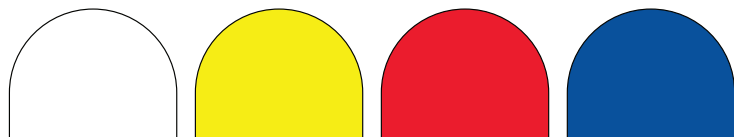

white

yellow

red

royal blue

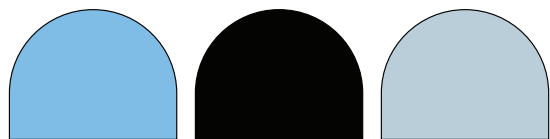

powder blue

black

silver



Side

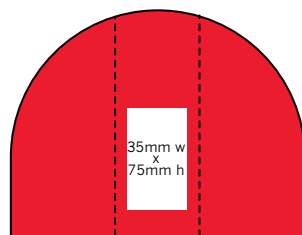

Front/Back

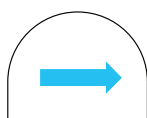

Any logo which must face the same direction on both sides of cap when worn will require separate screens for each side of cap.



Example of print position

- Minimum qty for silicone racing caps printing is 50pcs per colour/per logo colour
- Colours with minimum 200 pcs - any other colour from regular silicone colour range
- Available for 1 colour printing only.
- Competition caps will comply with FINA regulations on manufacturers mark and have 1 eyeline logo on all caps

Custom Printed Lycra/Polyester Caps

ELSCP

EPSCP

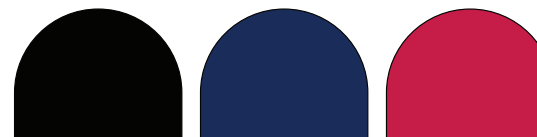

black

navy

red

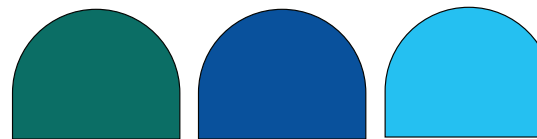

bottle green

royal blue

sky blue

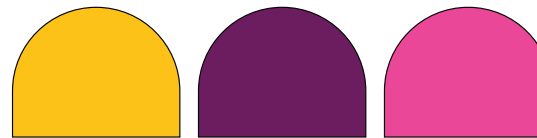

buttercup yellow

maroon

hot pink

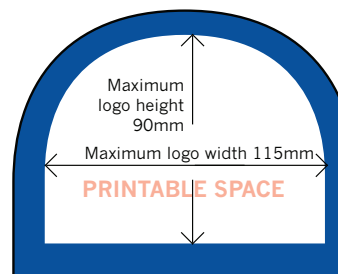

Side



Example of print position

- Minimum qty for lycra or polyester cap printing is 100pcs per fabric/per colour/per logo colour
- Available for 1 colour printing only.